

PLAN VIEW

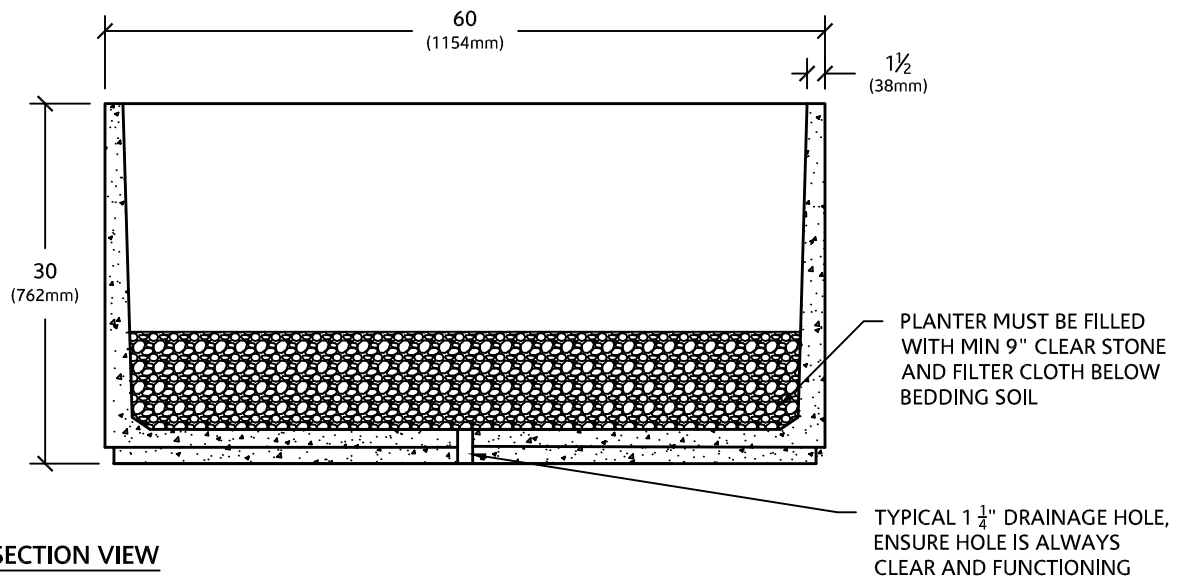

SECTION VIEW

NOTES:

1. CONTRACTOR TO REFER TO ARCHITECTURAL SPECIFICATIONS FOR COLOUR, FINISH AND VALUE ADDED FEATURES
2. SUBMIT COLOUR AND FINISH SAMPLES FOR APPROVAL
3. WEIGHT OF SQUARE SQ166030 PLANTER - 1200 lbs



SQUARE PLANTER

SQ166030

ED'S CONCRETE PRODUCTS
 1266 ERIE STREET
 STRATFORD, ONTARIO
 N4Z 0A1

1-877-265-6590
 www.edskoncrete.com
 info@edskoncrete.com

