

PLAN VIEW

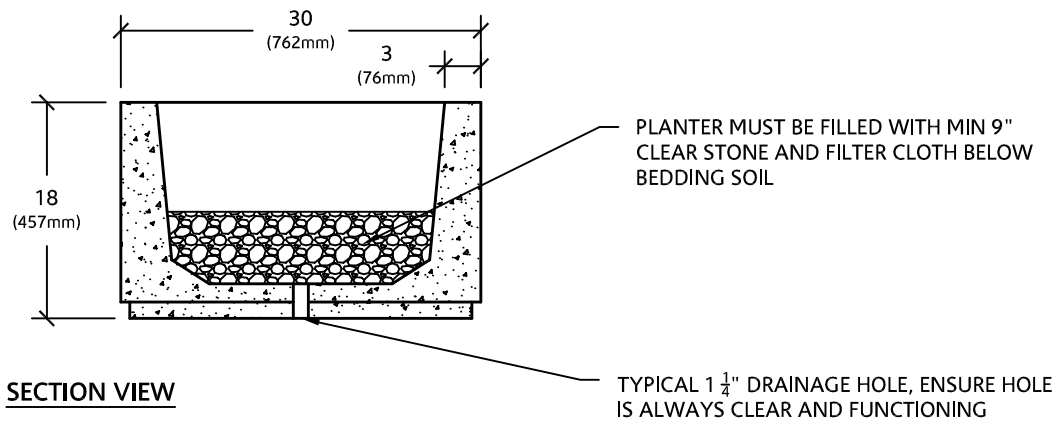

SECTION VIEW

NOTES:

1. CONTRACTOR TO REFER TO ARCHITECTURAL SPECIFICATIONS FOR COLOUR, FINISH AND VALUE ADDED FEATURES
2. SUBMIT COLOUR AND FINISH SAMPLES FOR APPROVAL
3. WEIGHT OF SQUARE SQ303018 PLANTER - 650 lbs



SQUARE PLANTER

SQ303018

ED'S CONCRETE PRODUCTS
1266 ERIE STREET
STRATFORD, ONTARIO
N4Z 0A1

1-877-265-6590
www.edskoncrete.com
info@edskoncrete.com

